

**Building The VegTrug**

Congratulations on your purchase of the VegTrug. Please go to [www.VegTrug.Com](http://www.VegTrug.Com) for instructions and tips on what you can grow and how to get the best use from your VegTrug. You can also see a video of the VegTrug build on the website or on the VegTrug iPhone App.

1. The VegTrug is very simple to assemble. Start by creating the H of the legs by using the bolts, washers and nuts, placing them through the pre-drilled holes as shown in the picture. Gently tap the head of the bolt into the hole so that it fits snugly into the leg. At this stage, do not tighten up the bolts completely, but leave them loose so that there is some lateral movement in the vertical leg posts. There should be a notch on the top of the cross bar, ready to locate the spine of the VegTrug. Ensure this is facing up.
2. Stand the legs in a line on the ground and then place the 'spine' of the VegTrug through the centre of the H securing with the screws as indicated.
3. Next place the pre-formed side boards on the VegTrug as shown in the picture. You can ensure that they are the right way up because the pre-drilled holes are at the top of the posts. Line up the top edge of the side boards with the top of the VegTrug leg posts. This will ensure that there is a gap at the bottom between the boards and the spine. Secure the boards in place with the screws provided using the pre-drilled holes making sure that the VegTrug is standing square. The batons should be on the outside of the VegTrug.
4. Offer up the V shaped end boards to the VegTrug. They should fit snugly and correctly lining up with the ends of the sideboards. At this stage, secure them with one screw in either side to hold them in place.
5. Offer up the top side boards of the VegTrug and ensure that they meet the V shaped end boards correctly showing a level, even finish to the top of the VegTrug all round. If the boards do not connect properly, stand at the end of the VegTrug with your feet inside the legs and move the H in or out so that all the boards meet and all the screw holes line up correctly.
6. Once it is all in place, secure all the boards using the screws provided as shown in the picture.
7. Remember to tighten up the leg bolts at the end of the process. There is no need to over-tighten them - just enough so that there is resistance and they will not come undone by hand.

**Using The VegTrug**

After you have put the VegTrug together, simply place the pre-formed liner into the VegTrug so that the top edge overlaps. Fold the liner back over the top edge of the VegTrug and then pull the draw string tight to tighten the liner and hold it in place whilst you fill the VegTrug with a suitable potting mix. Fill to within 2-4 cm of the top edge. Once the potting mix is in place, you can release the draw string and tuck the liner down to be level with the potting mix. It is a good idea to put the VegTrug in place before you fill it with potting mix!

Your VegTrug is now ready for planting. Go to [www.VegTrug.Com](http://www.VegTrug.Com) or download the VegTrug iPhone App to see what you can grow!

The Medium (1.8m) VegTrug will take around 420 Litres of potting mix and the Small (1m) VegTrug will take 210 Litres of potting mix and the Mini (75cm) will take around 160 Litres of potting mix.

**Maintaining The VegTrug**

All VegTrugs are finished with a water based preservative that is food and vegetable safe. The colour of the VegTrug will naturally fade with time and this very much depends on the weather, heat and humidity as well as the colour of the finish. As such we cannot guarantee that the colour will not fade quickly and we cannot give any warranty relating to the colour fading of the VegTrug. The product should be treated on an annual basis as a minimum. Ensure that you use a food safe water based preservative on the VegTrug.

As a raw material, wood will naturally contract and expand due to the humidity, heat and seasons. Hairline cracks may appear to open or close accordingly. This movement in the material will be reduced and controlled with regular re-treatment of the product.

Please note the VegTrug Liner should be 'tucked in' level with the soil in accordance with the instructions above and not left 'flapping' over the edge of the VegTrug. If exposed to the elements it will naturally tear and degrade. Please tuck the liner in so this does not happen.

Replacement liners and VegTrug greenhouse frames and covers can be purchased from your local stockist.

# VegTrug Medium

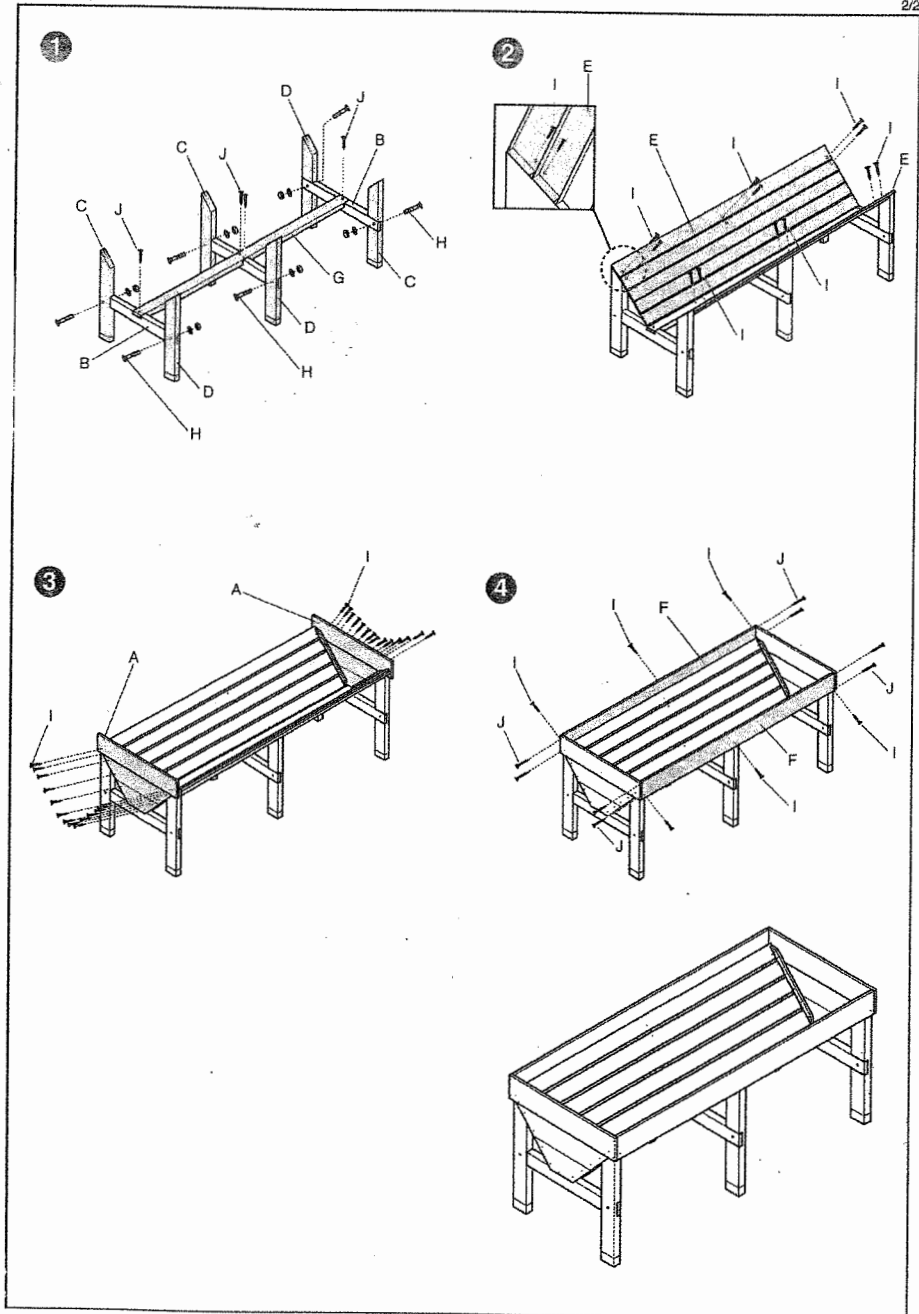

**LGFPE 1140**  
**LGFMMC 1141**  
**MGFPE1144**  
**MGFMMC1145**

**Large Greenhouse Frame and PE Cover**  
**Large Greenhouse Frame and M/Mesh Cover**  
**Medium Greenhouse Frame and PE Cover**  
**Medium Greenhouse Frame and M/Mesh Cover**

T-0208110 1/2

### Conditions for Use

Please read carefully the explanations below to avoid any possible injuries and to get best use from this product.

- At the time of assembly, please refer to the user manual and follow the instructions.
- Please don't use the product anywhere you feel is dangerous and/or may disturb others.
- This is not a toy. Please don't use the product for any other purpose than the original intended use.
- Please don't make any changes to the product.
- Please don't put your fingers and/or hands between the gaps of frames.
- Please don't use the product in very windy places. It may collapse.
- Please don't use the product close to fire and/or high temperature. It may cause distortion and/or fire.
- Please don't drag the product when you'd like to move it. It may scratch the floor.
- The plastic cover is water-resistant but please don't put anything other than water into the structure.
- Please gently open and close the zips. If you use too much force, it may break.
- This greenhouse itself will not generate any heat and warm up the plants inside. The temperature will change according to the outside environment.
- Please don't use the greenhouse when there is heavy snow. When you see snow settled on the greenhouse, please remove the snow.
- Please don't let your children play with the cover to avoid danger of suffocation.

### Please Note

- This product is for standard home use. Please don't use it in public and commercial spaces.
- This product may get rusty and/or the colour may fade and/or the material may deteriorate.
- Due to UV rays, the colour of the cover may change.
- The frame is coated but the surface coating colour may fade and/or the material may deteriorate. This may happen much sooner when you use the product close to the sea or places with heavy traffic. The frame will also get rusty from small scratches and/or joint areas.
- The expected lifetime of the cover is approx. 1-2 seasons.
- The use of this product does not guarantee plant growth.
- Depending on the environment and kind of plants, the greenhouse may not function. Please ask your nearby home centre and/or garden centre for further advice.

### Cleaning

- When you clean the product, please use a soft dry cloth.
- When it's very dirty, please use a diluted neutral detergent.

### Maintenance

- Please check the joints to make sure they have not become loose.
- The frame is painted but please repaint when you find even a small scratch.
- When you paint, please do so in an open space and follow the paint manufacturer's instructions.
- Please clean off any dirt before you paint.
- In order to use the product for a longer period, we'd recommend that you remove the cover and store when not in use.

### Helpful information

- Choose a sheltered position for your Vegtrug Greenhouse.
- Good light is needed for plants but not direct fierce sunlight.
- The greenhouse may get very hot - we recommend regular watering and ventilation to aid plant growth.

Products designed for use with Vegtrugs:

Greenhouse cover  
Insect protection cover  
Fleece cover

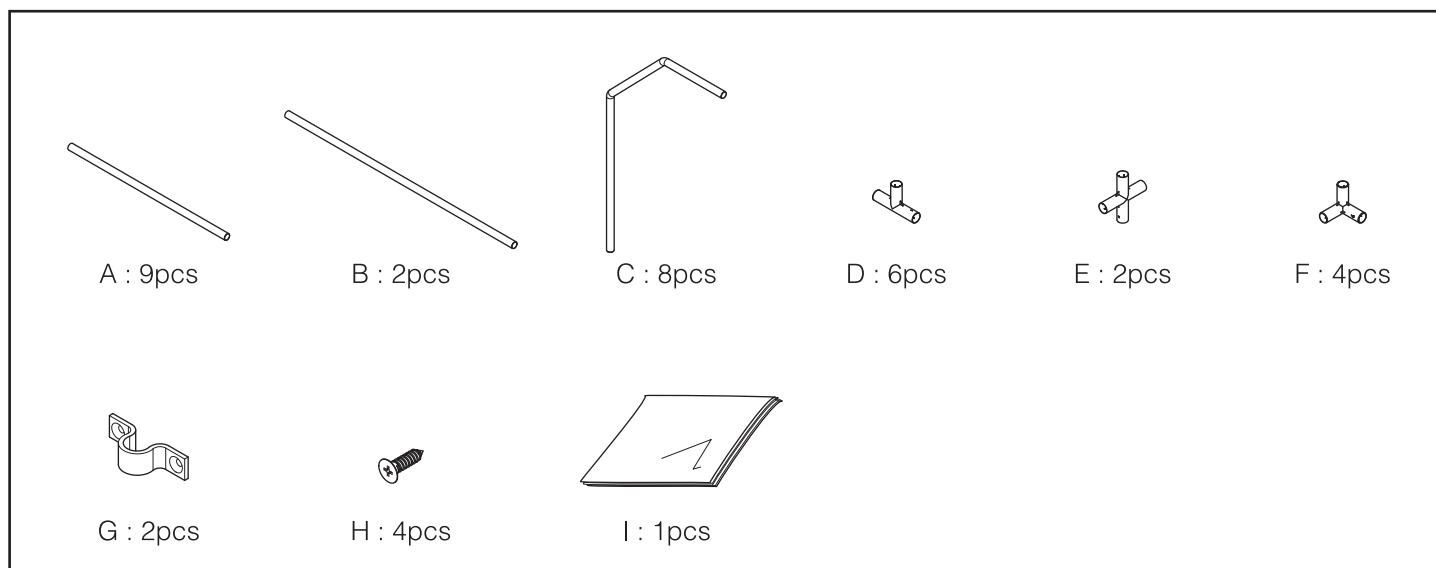

1

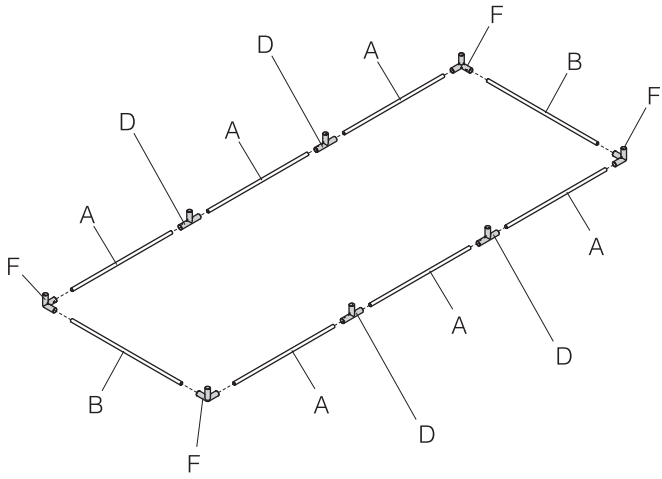

2

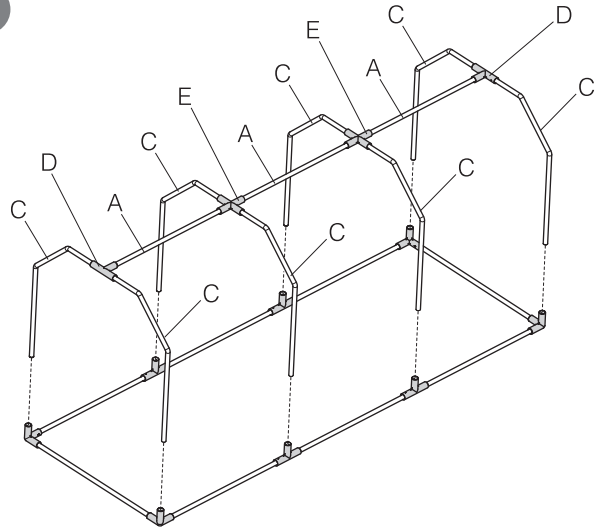

3

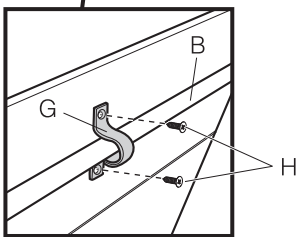
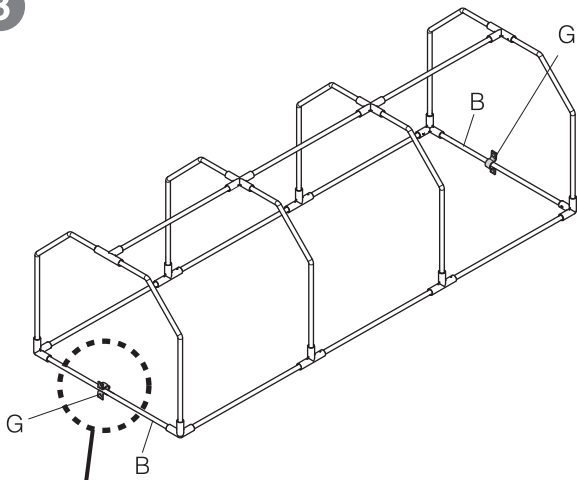

4

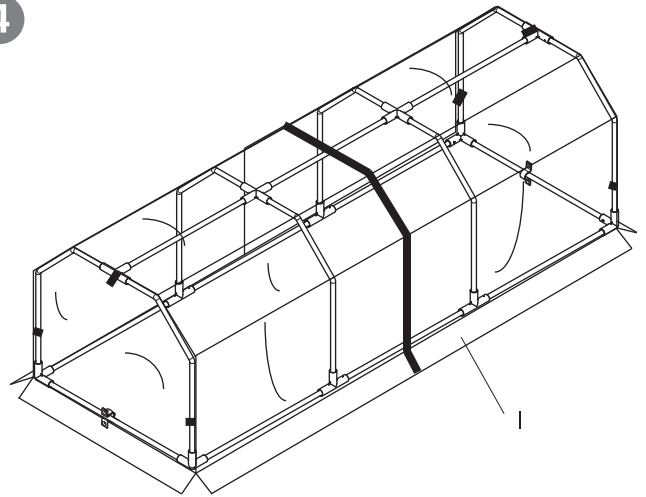

Cover for this frame is included in box and should be secured to frame using the velcro tabs.