



42"CAST ALUM. DINING TABLE





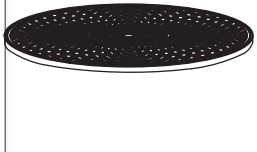
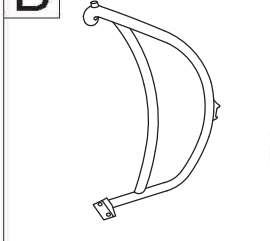
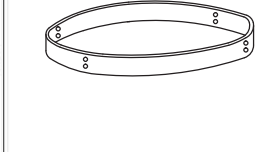

CO600142-BK





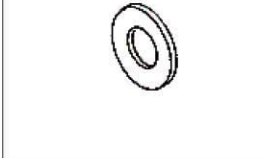

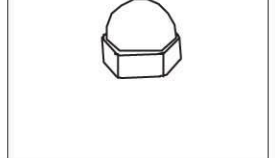

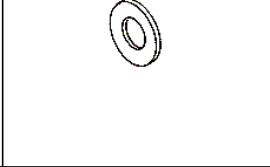
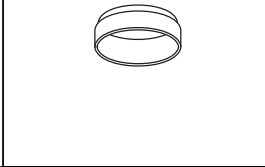
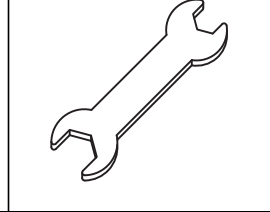

# PARTS LIST

<p><b>A</b></p> 	<p><b>B</b></p> 	<p><b>C</b></p> 
<p><b>Top</b> 1 PC</p>	<p><b>Leg</b> 4 PCS</p>	<p><b>Stretcher</b> 1 PC</p>

# HARDWARE LIST

<p><b>1</b></p> 	<p><b>2</b></p> 	<p><b>3</b></p> 	<p><b>4</b></p> 	<p><b>5</b></p> 
<p><b>Cylinder Bolt</b> (M8*25) 4 PCS</p>	<p><b>Spring Washer</b> (M8) 4 PCS</p>	<p><b>Flat Washer</b> (M8) 4 PCS</p>	<p><b>Nut (M8)</b> 4 PCS</p>	<p><b>Nut Cap (M8)</b> 4 PCS</p>
<p><b>6</b></p> 	<p><b>7</b></p> 	<p><b>8</b></p> 	<p><b>9</b></p> 	
<p><b>Bolt</b> (M6*30) 8 PCS</p>	<p><b>Flat washer</b> (M6) 8 PCS</p>	<p><b>Bolt cap</b> (M6) 8 PCS</p>	<p><b>Wrench</b> (M6) 1 PC</p>	

- |                      |   |     |
|----------------------|---|-----|
| ① Bolt (M8*25)       |  | x 4 |
| ② Spring Washer (M8) |  | x 4 |
| ③ Flat Washer (M8)   |  | x 4 |
| ④ Nut (M8)           |  | x 4 |
| ⑤ Nut Cap (M8)       |  | x 4 |
| ⑥ Bolt (M6*30)       |  | x 8 |
| ⑦ Flat Washer (M6)   |  | x 8 |
| ⑧ Bolt Cap (M6)      |  | x 8 |

Step 1: Place Top (A) upside down on a soft cloth.

Insert all Cylinder Bolts (Part #1) into the pre-drilled holes of Top (A).

Step 2: Attach two adjacent Legs (B) to Top (A) by inserting the Cylinder Bolts (Part #1) through the holes in the ends of the Legs (B). Now secure the Legs (B) using Flat Washers (Part #3), Spring Washers (Part #2) & Nuts (Part #4).  
Note - -Tighten Nuts only half way using wrench (#9) .

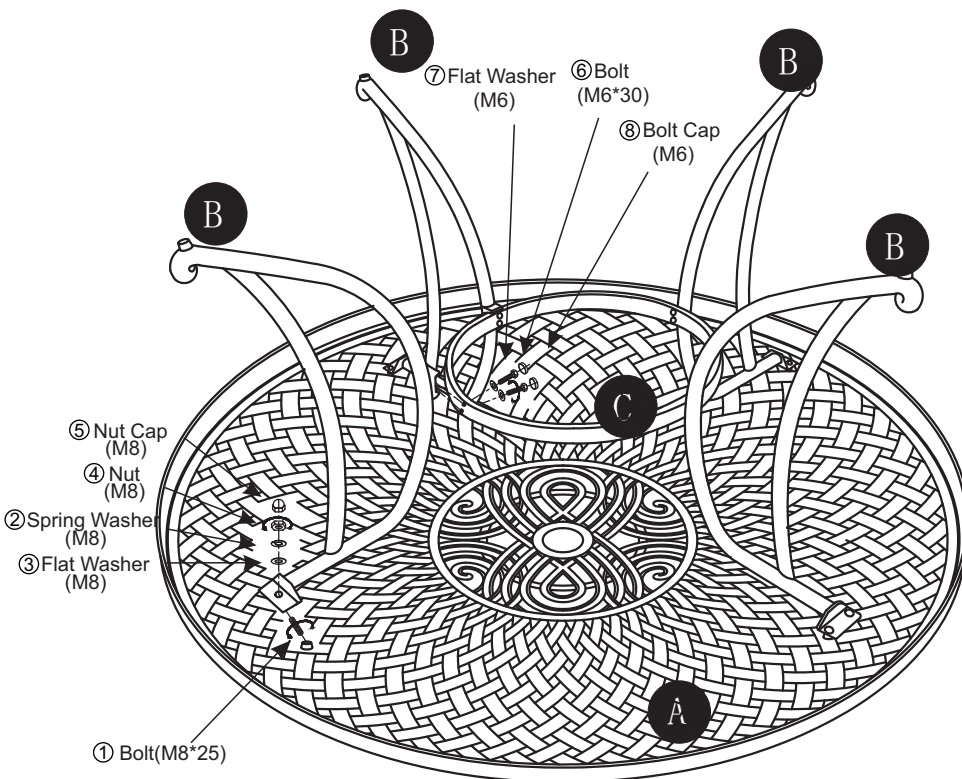

Step 3: Attach Stretcher (C) to attached Legs (B) using Flat Washers (Part #7), and Bolts (Part #6) as shown. Note - Tighten Nuts only half way with wrench (#9). Now attach the other two Legs (B) to Top (A) & Stretcher (C) using the same method as the first two legs. Tighten all bolts completely with wrench (#9).

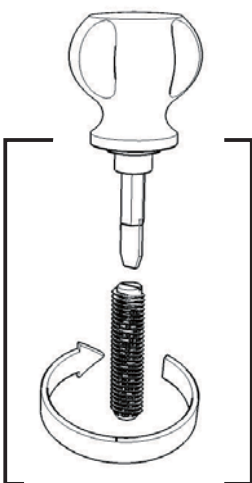

Figure 1

Flathead screw driver(not included)

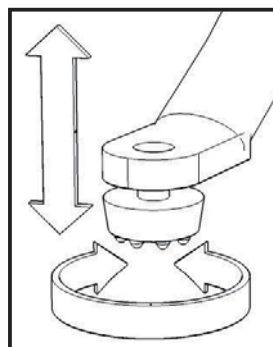

Figure 2





Step 4: Cover all Nuts and bolts with Nut Caps (Part #5) & Bolt Caps (Part #8). Turn the table over into the upright position in your congratulations! You are finished.









CAST ALUMINUM  
HIGHBACK ARM CHAIR  
CO6102-BK



# PARTS LIST

<p><b>A</b></p> 	<p><b>B</b></p> 	<p><b>C</b></p> 	<p><b>D</b></p> 	<p><b>E</b></p> 
<p>Seat 1 PC</p>	<p>Back 1 PC</p>	<p>Leg 1 PC</p>	<p>Left Arm 1 PC</p>	<p>Right Arm 1 PC</p>

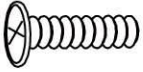
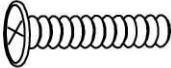
# HARDWAARE LIST

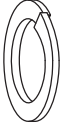
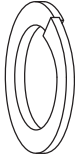
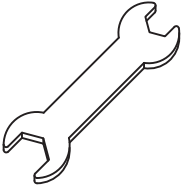
<p><b>1</b></p> 	<p><b>2</b></p> 	<p><b>3</b></p> 	<p><b>4</b></p> 	<p><b>5</b></p> 
<p>Flat Washer(M6) 4PCS</p>	<p>Flat Washer(M8) 10PCS</p>	<p>Nuts(M6) 4PCS</p>	<p>Nuts(M8) 10PCS</p>	<p>Short phillips Heat Bolt (M6*25) 2PCS</p>
<p><b>6</b></p> 	<p><b>7</b></p> 	<p><b>8</b></p> 	<p><b>9</b></p> 	<p><b>10</b></p> 
<p>Long phillips Heat Bolt (M6*30) 2PCS</p>	<p>Nut Caps(M6) 4PCS</p>	<p>Nut Caps(M8) 10PCS</p>	<p>Spring Washers (M6)4PCS</p>	<p>Spring Washers (M8)10PCS</p>
<p><b>11</b></p> 				
<p>Wrench (M6 &amp; M8) 1 PC</p>				

**Step:1** Place seat (A) upside down on a soft cloth. Attach Legs (C) to Seat (A) with, Flat washers(Part #2), Spring washers(Part #10),and Nuts(Part #4).Note - Do not tighten Nuts(Part #4) Completely at this time.

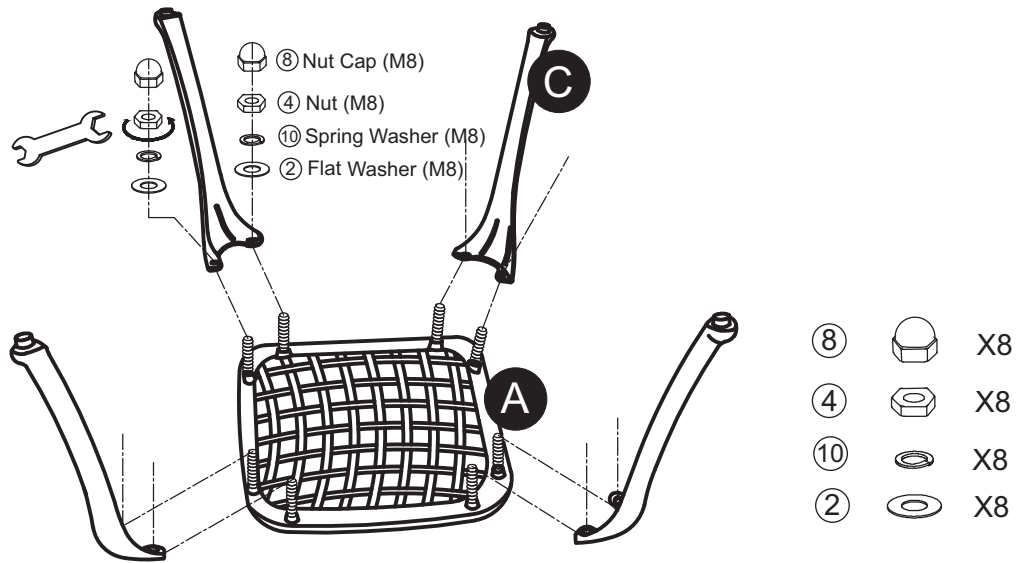

**Step:2** Attach Back (B) to Seat(A) with Flat Washers(Part #2),Spring Washers(Part #10) & Nuts(Part #4).Note - Do not tighten Nuts(Part #4) completely at this time.

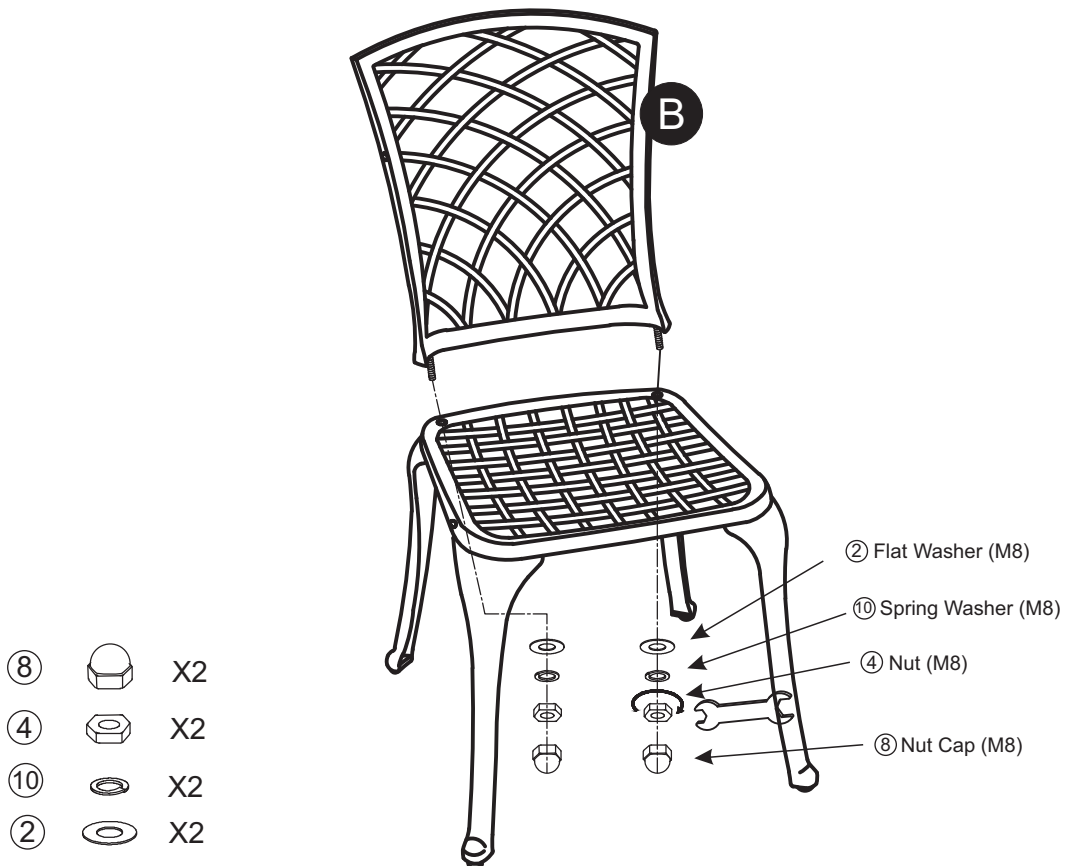

**Step:3** Attach Arms (E&D) with Short Phillips Head Bolts(Part #5), Long Phillips Head Bolts(Part #6),Flat Washers(Part #1), Spring Washers(Part #9) & Nuts(Part #3).Completely tighten all Nuts(Part #'s 3 & 4) and cover whit Nut Caps (Part #'s 7 & 8).

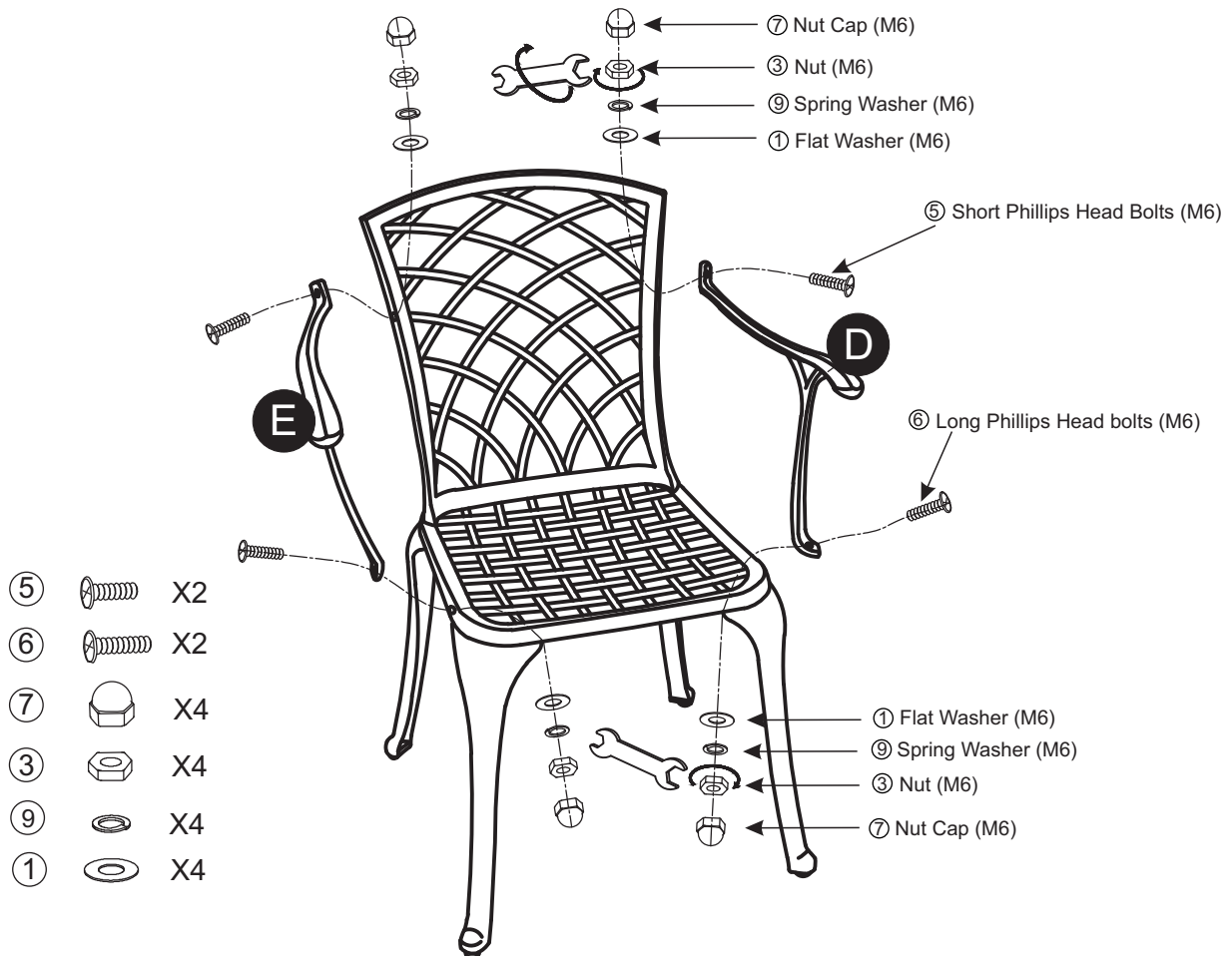

**Step:4** Congratulation!  
You are finished

